

MICRODYN *iSep*[™]
500 Ultrafiltration
Modules
Product Manual

Contact

Europe

Germany: +49 611 962 6001
Italy: +39 0721 1796201
info@microdyn-nadir.com

Americas

USA: +1 805 964 8003
sales.mnus@microdyn-nadir.com

Asia

Singapore: +65 6457 7533
China: +86 10 8413 9860
waterchina@mann-hummel.com

Table of Content

1	Introduction.....	4
2	Features & Benefits.....	5
2.1	INTEGRATED TANK DESIGN.....	5
2.2	FREQUENT DRAINING.....	5
2.3	OPEN FLOW CHANNELS.....	5
2.4	MEMBRANE AERATION	6
2.5	HIGH EFFLUENT QUALITY	6
2.6	NEGATIVE PRESSURE	7
2.7	SKID-MOUNTED DESIGN.....	7
2.8	LOW-FOULING MEMBRANE CHEMISTRY.....	7
3	MICRODYN <i>iSep</i> [™] 500 UF Module Assembly.....	8
4	Module Specifications	9
4.1	MEMBRANE SPECIFICATIONS.....	9
4.2	MODULE CONNECTIONS & DIMENSIONS	9
5	MICRODYN <i>iSep</i> [™] 500 UF Process Description	10
6	Operational Sequences	11
6.1	SAFETY SYMBOLS (DANGERS, WARNINGS AND CAUTIONS)	12
6.2	BACKWASH	13
6.3	CHEMICALLY ENHANCED BACKWASH (CEB).....	13
6.4	CLEAN-IN-PLACE (CIP)	14
6.5	GUIDELINES OF OPERATION	15
6.6	SYSTEM MONITORING	17
6.7	SHIPPING AND STORAGE.....	17

1 Introduction

Sustainable fresh water supplies are diminishing at an unprecedented rate due to increasing populations, agricultural use and rising industrial demand. Wastewater recycling using ultrafiltration (UF) membranes has become a new and viable water source. Ultrafiltration provides safe, reliable and high quality effluent that can be used for a multitude of water reuse applications. The utilization of new water sources is also realized due to the high level of pretreatment ultrafiltration is able to provide for reverse osmosis (RO) systems.

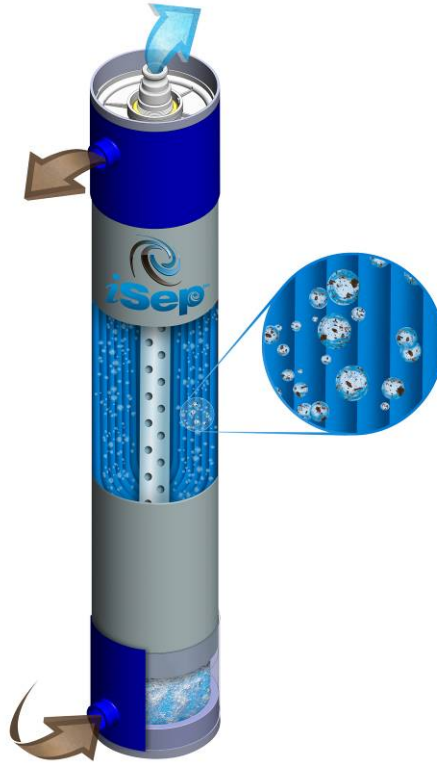

Figure 1. MICRODYN *iSep*™ 500 UF Module

MICRODYN *iSep*™ 500 UF modules were designed for high fouling water and wastewater streams and provides a lower overall cost to plant owners. The unique low-fouling properties result in:

- Lower pretreatment requirements
- Higher flux rates
- Lower energy

Extensive pretreatment for UF systems, such as clarifiers, adds significant and unnecessary cost, footprint and complexity. With the ability to directly treat some of the most difficult water and wastewater streams, *iSep* is able to drastically reduce capital and operational costs while simplifying the overall treatment process.

2 Features & Benefits

MICRODYN *iSep*™ 500 UF modules are the first to incorporate the various design features and benefits of both pressurized and submerged UF and microfiltration (MF) systems:

- **Integrated Tank Design:** Membrane element and tank have been integrated into a single, encapsulated module eliminating the need for a large process tank.
- **Frequent Draining:** High tank intensity design allows for frequent draining, effectively purging solids from the membrane module resulting in lower fouling.
- **Membrane Aeration:** The open flow channels enable aggressive air scouring where bubbles “scrub” the membrane surface clean.
- **High Effluent Quality:** The strong, durable design of the *iSep* element eliminates mechanical failures, ensuring high quality effluent throughout the life of the element.
- **Membrane Backwash:** Periodic backwash purges particulate matter from the membrane surface.
- **Skid-Mounted Design:** Simplifies installation and maintenance while eliminating the need for a membrane tank.
- **Low-Fouling Membrane Chemistry:** Hydrophilic PVDF chemistry enhances membrane fouling and permeability characteristics.

2.1 INTEGRATED TANK DESIGN

Traditional submerged membrane systems typically consist of a series of membranes immersed in a common process tank. The *iSep* module design integrates the tank and membrane into one module. In essence, the membrane element has now become its own individual tank.

2.2 FREQUENT DRAINING

A common problem with submerged membrane designs is the inability to frequently and effectively purge all solids from the membrane system. Accumulated solids can lead to unwanted sludge layers that are easily agitated, causing TSS spikes in the system. It is impractical to drain the membrane tank on a frequent basis as it wastes a tremendous amount of water while increasing down time.

By integrating the membrane and tank into a single module, the volume of water is minimized making it practical and feasible to drain the water on a frequent basis. With *iSep*, the TSS concentration never reaches a steady-state value as the feed solution is completely removed and replenished with “fresh” feed after every backwash. As a result, the solids profile inside the element has a “saw-tooth” pattern (as shown in Figure 2). This reduces, in some cases, the average TSS concentration by 40 – 50% compared to traditional submerged membrane systems.

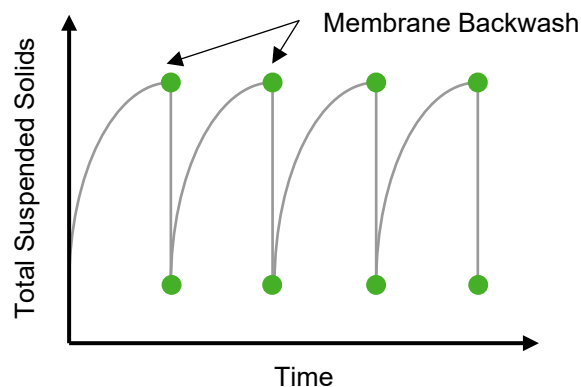

Figure 2. Total Suspended Solids (TSS) profile in *iSep* UF membranes.

2.3 OPEN FLOW CHANNELS

A key feature of the MICRODYN *iSep*™ 500 UF module is a specialized, corrugated feed spacer which creates open flow channels in the element. Conventional feed spacer materials used in RO spiral wound membranes are unsuitable for high TSS operation. As result, MICRODYN-NADIR engineers developed a corrugated sheet that creates a wide, open feed channel that prevents fouling. Air is able to flow upward through each individual flow channel and scrub solids from the membrane.

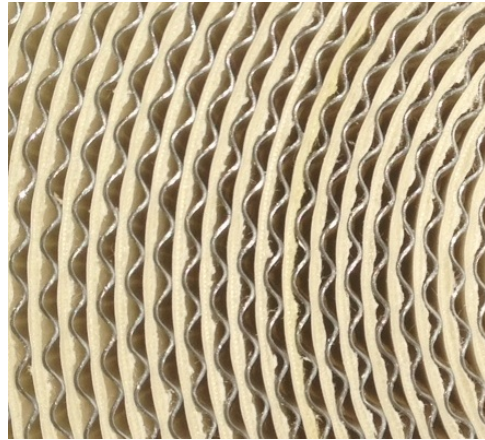

Figure 3. Corrugated flow channel spacer.

2.4 MEMBRANE AERATION

Membrane air scour is a critical operating feature of all UF/MF wastewater systems. Air bubbles generate tremendous shear forces that actively scour, or “scrub”, the membrane surface. In order to realize the benefits of air scour, the membrane design must maintain bubble-to-membrane surface contact. The corrugated feed spacer contains open flow channels, ensuring air bubbles maintain contact with the membrane surface.

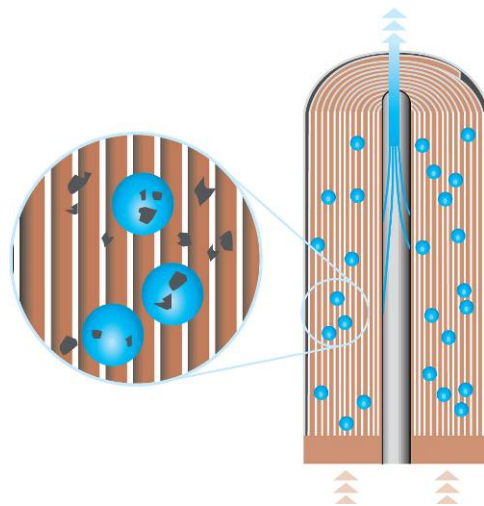

Figure 4. Membrane air scour.

2.5 HIGH EFFLUENT QUALITY

Effluent quality is tied directly to membrane integrity and is a critical feature when operating RO pretreatment systems. The rigid, durable design of MICRODYN *iSep*™ 500 UF modules ensures that membrane integrity is not compromised. This guarantees a high effluent quality far exceeding current market standards. Typical effluent quality parameters are:

- TSS < 1.0 mg/L
- Turbidity < 0.1 NTU
- SDI < 3.0

2.6 NEGATIVE PRESSURE

Negative pressure systems are the preferred method of operation for high fouling water and wastewater applications. Submerged systems rely on centrifugal pumps to generate a slight vacuum, “pulling” water through the membrane barrier layer. Vacuum operation generates ultra low trans-membrane pressures which reduce membrane compaction and energy consumption.

2.7 SKID-MOUNTED DESIGN

Submerged membrane systems have been hindered by the necessity for large, costly process tanks that comprise a significant portion of all upfront capital costs. By integrating the membrane and tank into a single encapsulated module, *iSep* allows for a fully skid-mounted design. Capital costs are reduced while simplifying membrane installation and maintenance. The materials of construction also ensure high chemical compatibility with sodium hypochlorite, caustic and acid.

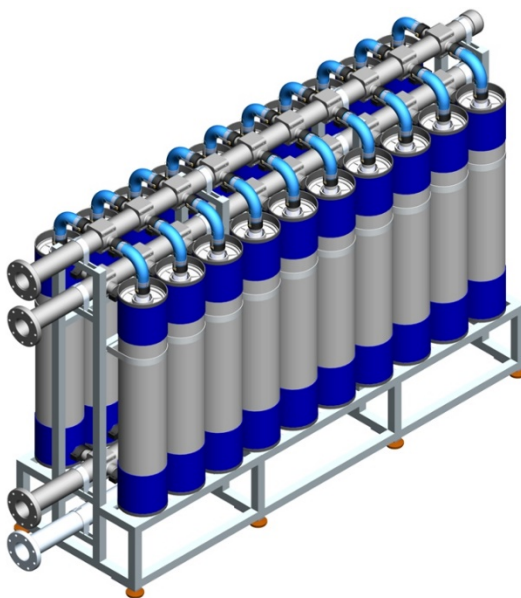

Figure 5. *iSep* UF Membrane Cassette.

2.8 LOW-FOULING MEMBRANE CHEMISTRY

MICRODYN-NADIR engineers developed a specially formulated, low-fouling membrane chemistry that increases permeability (i.e. membrane flux), reduces fouling and lowers energy consumption. The small 0.03 μm pore size, when compared to other UF/MF formats, prevents solids from penetrating the inner pores of the membrane. This causes solids to reside on the surface of the membrane where it is easily removed via air scouring and/or backwashing.

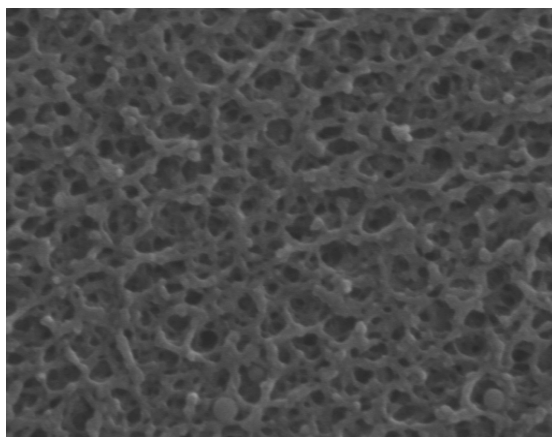

Figure 6. UF membrane surface.

3 MICRODYN *iSep*™ 500 UF Module Assembly

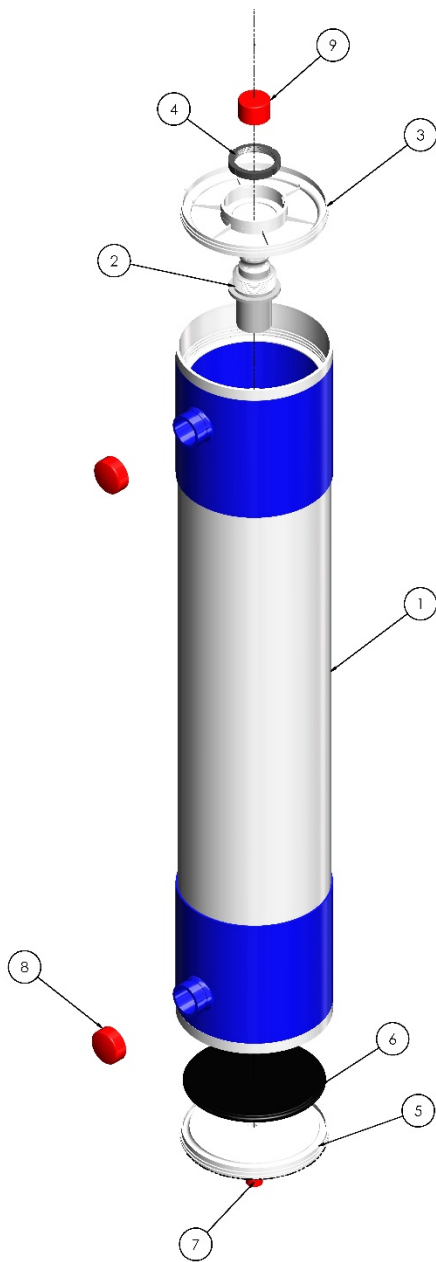

TABLE 1. MICRODYN *iSep*™ 500 UF MODULE ASSEMBLY.

Item No.	Description	Qty.
1	<i>iSep</i> UF module	1
2	Permeate adapter; 38.1 mm (1.5 inch) cam lock connection	1
3	Module cover/cap	1
4	Module cover/cap locknut	1
5	Air diffuser base; 19.1 mm (3/4 inch) MNPT connection	1
6	Air diffuser membrane	1
7	Air diffuser cap plug (for shipping/storage only)	1
8	Feed/overflow ports cap plug (for shipping/storage only)	2
9	Permeate adapter cap plug (for shipping/storage only)	1

Figure 7. *iSep* UF module assembly.

4 Module Specifications

The following are specifications for MICRODYN *iSep*TM 500 UF modules.

4.1 MEMBRANE SPECIFICATIONS

TABLE 2. MEMBRANE SPECIFICATIONS *iSep* UF MODULES.

Parameter	<i>iSep</i> UF Module
Membrane Pore Size	0.03 μ m
Configuration	Submerged
Transmembrane Pressure (TMP) Range	0.07 – 0.7 bar (1 – 10 psi)
Feed Channel Spacing	2.3 mm (0.090 inches)
Temperature Range	1 – 45°C (34 – 113°F)
pH (Continuous)	2 – 11
pH (Cleaning)	2 – 11
Maximum Chlorine Exposure	2,000 mg/L

4.2 MODULE CONNECTIONS & DIMENSIONS

TABLE 3. CONNECTIONS & DIMENSIONS FOR *iSep* UF MODULES.

Item No.	Description	Specification
1	Overflow	50.8 mm (2.0 inch) grooved end
2	Feed/Drain	50.8 mm (2.0 inch) grooved end
3	Permeate	38.1 mm (1.5 inch) cam and groove
4	Air	19.1 mm (3/4 inch) MNPT

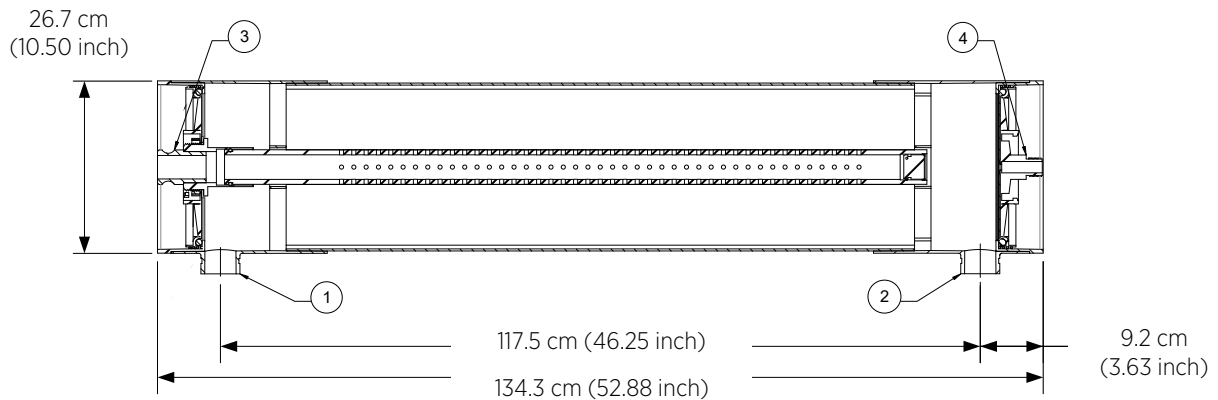

Figure 8. *iSep* UF module cross section.

5 MICRODYN *iSep*™ 500 UF Process Description

A system of MICRODYN *iSep*™ 500 UF modules is comprised of the following main components:

- *iSep* UF modules
- Cassette
- Manifolds
- Permeate pump
- Backwash pump
- Blower
- Chemical metering pump
- Valves & instrumentation
- PLC control system
- Pretreatment (where applicable)

A typical system configuration using *iSep* UF modules is shown below (Figure 9).

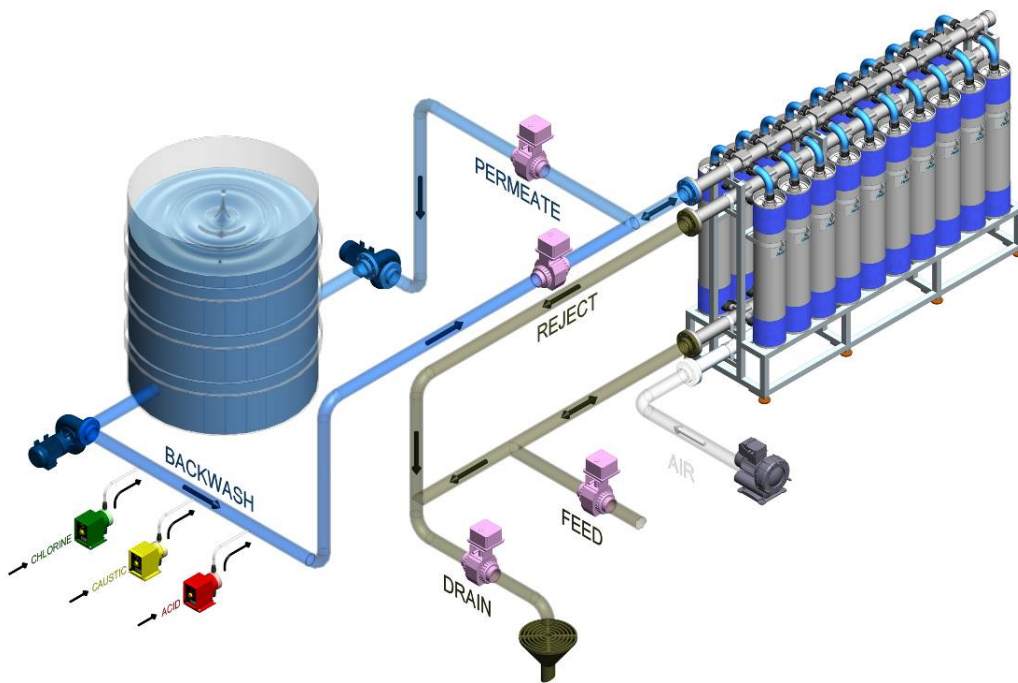

Figure 9. Typical system process flow diagram (PFD) using *iSep* UF modules.

iSep UF modules are mounted to a cassette frame that contains manifolds for each different process stream. Each individual manifold is then connected to main process headers for the UF system. Feed is delivered to the *iSep* UF modules via a pressurized source. The filtration process is driven by a self priming centrifugal pump which creates a slight vacuum, pulling water through the *iSep* membrane. Air is delivered to a specially designed aeration disc in each individual element.

Periodically, on a timed basis, UF permeate is backwashed through the membranes via a separate centrifugal pump (the system can also be configured so that permeate and backwash water are delivered using the same pump). Reject (i.e. retained solids) is removed from the *iSep* modules through the overflow port and/or element draining.

Pretreatment options and requirements vary depending on the application and water source to be treated. As a rule of thumb, a coarse screen (1 – 2 mm) should be used to remove large debris from the feedwater. In some applications with high COD, BOD, and/or TOC levels, systems using *iSep* modules may benefit from the injection of coagulant into the feed. Please consult MICRODYN-NADIR on recommended coagulation processes.

6 Operational Sequences

Operating of a system using MICRODYN *iSep*™ 500 UF modules consist of the following operational sequences:

- Production
- Backwash
- Chemically Enhanced Backwash (CEB)
- Clean-In-Place (CIP)

A summary of the different sequences and the system components utilized in each sequence are shown in Table 4.

TABLE 4. OPERATIONAL SEQUENCE MATRIX.

Equipment	Production	Backwash	Chlorine CEB	Caustic CEB	Acid CEB	Chlorine CIP	Caustic CIP	Acid CIP
Permeate Pump	X							
Blower	X							
Backwash Pump		X	X	X	X	X	X	X
Chlorine Pump			X			X		
Caustic Pump				X		X	X	
Acid Pump					X			X
Coagulant Pump	X							
Feed Valve	X							
Permeate Valve	X							
Backwash Valve		X	X	X	X	X	X	X
Drain Valve		X						

Note: The use of the drain valve during a backwash sequence occurs at the very end of the sequence, not during actual backwash.

6.1 SAFETY SYMBOLS (DANGERS, WARNINGS AND CAUTIONS)

In a system using MICRODYN *iSep*™ 500 UF modules, an array of membrane manifold assemblies is submerged in a common process tank. Each membrane manifold assembly is connected to a main header which is connected to the permeate pump. Feed is delivered to the *iSep* membranes through a common header. A vacuum is generated by the suction of a self-priming centrifugal pump, creating the necessary net drive pressure to “pull” water through the *iSep* membrane. Air is bubbled up through each membrane element via bubble diffusers, creating tremendous shear forces on the membrane surface that remove any suspended solids. Table 5 shows the sequence events for production, including the backwash sequence.

TABLE 5. PRODUCTION SEQUENCE OF EVENTS.

Equipment	Sequence (Step No.)			
	Module Fill (1)	Production (2)	Backwash (3)	Module Drain (4)
Permeate Pump		X		
Blower	X	X		
Backwash Pump			X	
Chlorine Pump				
Caustic Pump				
Acid Pump				
Coagulant Pump	X	X		
Feed Valve	X	X		
Permeate Valve	X	X		
Backwash Valve			X	
Drain Valve				X
Approximate Duration	30 - 60 sec	15 - 30 min	30 - 60 sec	30 sec

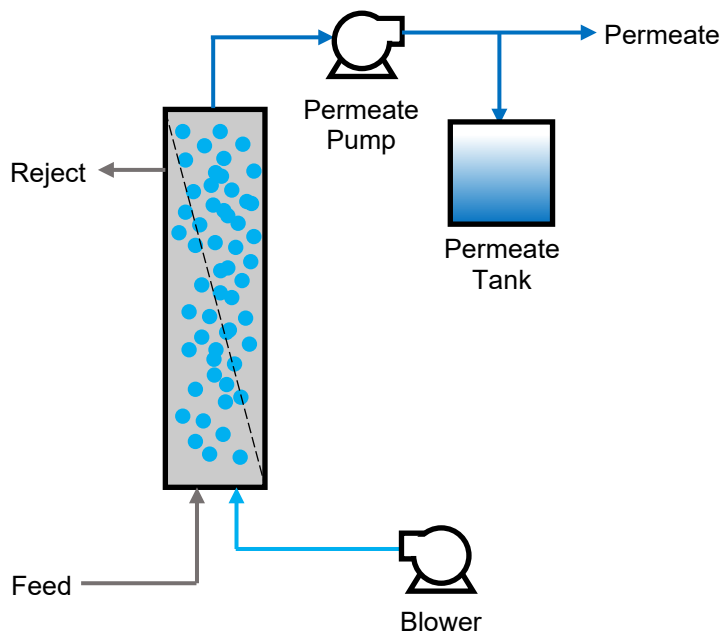

Figure 10. Production process.

6.2 BACKWASH

Periodically (on a timed basis), permeate water is reversed through the membrane, or backwashed, to help further remove accumulated suspended solids. This process may also be utilized to introduce a small amount of disinfectant (when required) to help control microbial activity on the membrane surface. The MICRODYN *iSep*™ 500 UF modules are drained at the end of every backwash cycle to purge solids from the membrane. Typically, a common drain valve is opened and water flows via gravity through the drain line. Once the modules have been drained, the system goes back into production.

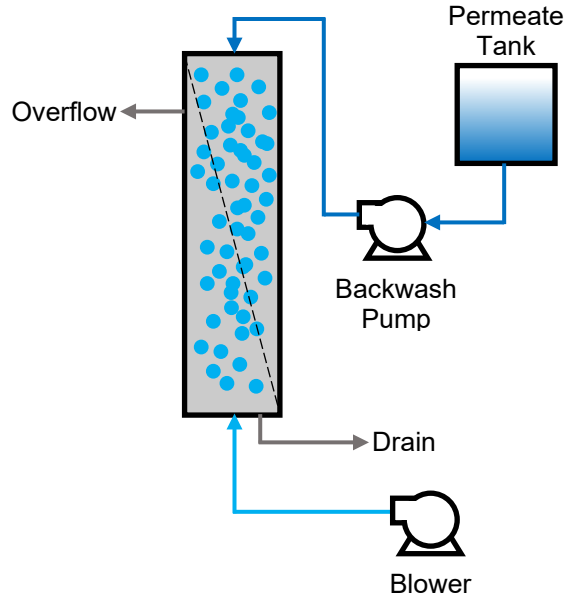

Figure 11. Backwash process.

6.3 CHEMICALLY ENHANCED BACKWASH (CEB)

A chemically enhanced backwash (CEB) is a maintenance cleaning procedure designed to quickly remove particulate matter and microbial growth from the membrane surface. These short, mini cleans will help prolong run times between major membrane cleanings. CEBs can be performed with either chlorine, caustic or acid with chlorine and acid being the most common procedures. A chlorine CEB is typically performed daily on wastewater applications, while an acid CEB is usually performed once every couple days. Typical chlorine concentrations in a CEB are 100 mg/L, but may be higher or less depending on the feedwater source. Acid CEBs are performed at a pH between 2.0 - 3.0. Tables 6 and 7 show the CEB sequence of events and typical set-points.

TABLE 6. CEB SEQUENCE OF EVENTS.

CEB Operational Steps	Backwash Pump	Metering Pump	Backwash Valve	Drain Valve
1. Production is stopped				
2. Modules are drained				X
3. Cleaner is backwashed into element	X	X	X	
4. Modules undergo static soak				
5. Modules are backwashed	X			
6. Cleaning solution is drained				X
7. Production is resumed				

TABLE 7. TYPICAL CEB SET-POINTS.

CEB Type	Frequency (days)	Dosage (mg/L)	CEB pH	CEB BW (sec)	CEB Soak (min)	CEB Flush (sec)
12.5% NaOCl	1	100	-	51	15	30
30% NaOH	1	250	10.5 - 11.0	51	15	30
50% Citric Acid	3	2,000	2.0 - 3.0	51	15	30

The first step of a CEB is to drain the elements of all feed water. Once the elements have been drained permeate water, along with either sodium hypochlorite or acid, is backwashed through the system until the water level fully submerges the membrane elements. The membranes are then allowed to soak in the CEB cleaning solution for a period of 15 – 30 minutes. Following the static soak the membranes are briefly backwashed for 30 – 60 seconds to dislodge and flush particulate matter from the membranes. Before resuming permeate production the elements are completely drained. The spent CEB chemical solution is typically delivered to an appropriate collection system for neutralization prior to disposal (if required).

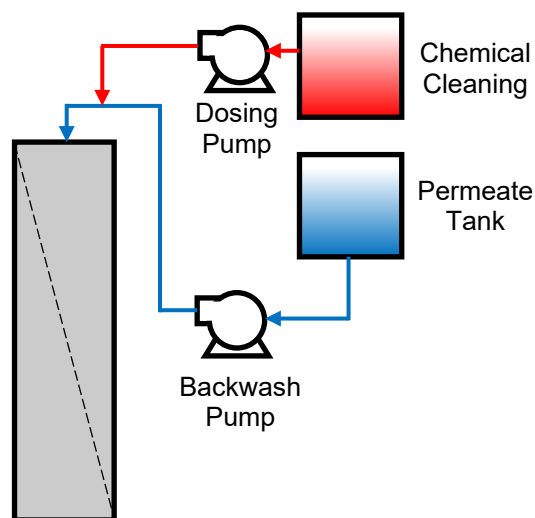

Figure 12. CEB process.

6.4 CLEAN-IN-PLACE (CIP)

Eventually a full-scale clean-in-place (CIP) is performed when the maximum TMP of the ultrafiltration system is reached. As a general guideline, the maximum TMP of submerged membrane system is 0.7 – 0.8 bar (10.0 – 12.0 psi) as this is typically the maximum vacuum pressure centrifugal pumps can generate. It is recommended that a CIP be initiated when the TMP reaches 0.7 bar (10.0 psi). CIP frequencies depend on the severity of the feedwater (i.e., fouling).

TABLE 8. CIP SEQUENCE OF EVENTS.

CEB Operational Steps	Backwash Pump	Metering Pump	Backwash Valve	Drain Valve
1. Production is stopped				
2. Modules are drained				X
3. Cleaner is backwashed into element	X	X	X	
4. Modules undergo static soak				
5. Modules are backwashed	X			
6. Cleaning solution is drained				X
7. Production is resumed				

A CIP process consists of an extensive chemical soak using either chlorine or acid (CIP processes can be used with specialty cleaners, please consult with MICRODYN-NADIR for recommendations). Typical chlorine concentrations for a CIP range between 1,000 – 2,000 mg/l while acid CIPs are performed at a pH of 2.0 – 3.0.

The CIP process is as follows: after the feedwater is drained from the membranes, UF permeate and cleaning chemical is backwashed through the system until the membrane elements are fully submerged. The membranes are allowed to soak in the cleaning solution for a period of a minimum of two (2) hours, preferably four (4). Additional backwashing is performed for 30 – 60 seconds after the static soak to help remove additional solids and particulate matter from the membranes. The cleaning solution is removed and delivered to an appropriate neutralization process prior to disposal (if required).

TABLE 9. TYPICAL CIP SET-POINTS.

CIP Type	Frequency (days)	Dosage (mg/L)	CIP pH	CIP BW (sec)	CIP Soak (hours)	CIP Flush (sec)
12.5% NaOCl	30	2,000	-	51	2 - 4	30
30% NaOH	30	250	10.5 - 11.0	51	2 - 4	30
50% Citric Acid	30	2,000	2.0 - 3.0	51	2 - 4	30

Note: Chlorine CIP may be pH adjusted up to 10.0 - 11.0.

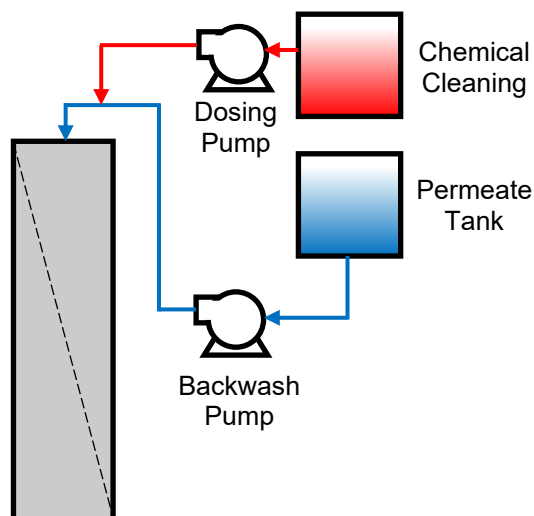
**Figure 13.** CIP process.

6.5 GUIDELINES OF OPERATION

MICRODYN-NADIR provides all data in good faith and believes the information and data contained herein to be accurate and useful. It is the user's responsibility to determine the appropriateness of MICRODYN *iSep*™ 500 UF modules for the user's specific end uses.

Suspended Solids

- Waters high in suspended solids may require higher cleaning frequencies and may result in shorter membrane life.
- Any changes in influent water quality that varies greatly from the design specification may cause significant differences in membrane performance.

Biological Matters

- Biological activity inside the element must be controlled during operation so that system water quality and quantity are not affected.

Chlorine

- The total free chlorine and bromine content of all water entering the *iSep* module(s) must be < 1,000 ppm for chemically enhanced backwashes. Maximum chlorine concentration for CIP processes is 2,000 mg/L.

Miscellaneous Chemicals

- Chemicals which form a water-immiscible phase in the feed or concentrate must not enter the module.
- Use of cationic, anionic or nonionic polyelectrolyte compounds in modules is not permitted unless prior written approval is given by MICRODYN-NADIR.
- Consult with MICRODYN-NADIR on the use of strong oxidants other than sodium hypochlorite.
- Impurities present in chemicals added to the feed water must not affect the module performance.

- Membrane damage caused by chemical compounds (e.g. surfactants, solvents, soluble oils, free oils, lipids and high molecular weight natural polymers) shall nullify and void the warranty.
- Failure to maintain the modules in a clean condition, unfouled by particulate matter, precipitates, suspended material or biological growth shall nullify and void the warranty.
- For coagulation chemicals, please consult with MICRODYN-NADIR for the appropriate selection.

pH

- The pH in the element must be > 2.0 for continuous operation. Elements must not be exposed to pH < 2.0 unless written approval is provided by MICRODYN-NADIR.
- For continuous operation, the pH in the elements must be < 11.0 up to 40°C (104°F) and < 10.0 up to 45°C (113°F). The maximum total allowable exposure time during operation and cleaning is 500 hours over the life of the element for solutions with pH 11.0 to 11.9 up to 40°C (104°F) and with pH 10.0 to 10.9 up to 45°C (113°F). Elements must not be exposed to pH > 11.9.

Cleaning

- The UF membranes will require chemical cleaning from time to time to remove suspended solids and other particulate matter from the membrane surface. Due to the unpredictability of wastewater applications, cleaning frequency, type and duration can vary from time to time.
- Maintenance cleaning, which consists of an extended chemically enhanced backwash, may be required from time to time in order to maintain membrane performance and operational ability. The frequency of a maintenance cleaning will vary due to the nature of the wastewater.
- Membrane CIP is recommended when the transmembrane pressure reaches a value of 0.55 bar (8.0 psi).
- Membrane CIP must be initiated when a transmembrane pressure of 0.70 bar (10.0 psi) is reached.

Operating Data

- The following UF system data is to be continually monitored, recorded and logged:
 1. TMP
 2. Permeate, feed and concentrate flow rates
 3. Air scour flow rate
 4. Feed and effluent turbidity
 5. Feed pH
 6. Temperature
 7. Backwash frequency, duration and flow rate
 8. Maintenance cleaning type and frequency
 9. Recovery clean procedures

Pretreatment

- The pretreatment system must be designed to prevent irreversible organic and/or inorganic fouling of the membrane.

Temperature & Pressure

- The product pressure must never exceed 0.7 bar (10 psi) greater than the feed pressure.
- The maximum temperature for operation of the element is 45°C (113°F). For operation outside this limit, written approval must be provided by MICRODYN-NADIR.

Element Flushing

- Flush water must be of good quality (meeting Guidelines) and of low TDS (<2000 ppm).

6.6 SYSTEM MONITORING

It is critical in the operation of a system using MICRODYN *iSep*™ 500 UF modules to properly monitor performance and water quality. All operating data should be normalized so that performance trends can be determined and analyzed. This will play a crucial role in determining when to clean the membranes.

The following data should be recorded for all *iSep* systems:

- Permeate, feed and concentrate flow rates
- Transmembrane pressure (TMP)
- Feed and turbidity
- Temperature
- Feed and permeate pH
- Aeration rate
- Backwash frequency and duration
- Backwash flow rate
- Backwash pressure

iSep operating data can be normalized by calculating a temperature corrected specific flux rate. Specific flux can be calculated using the following equation:

$$J = \frac{q_{\text{TCF}}}{\text{TMP}}$$

where

J = specific flux
 q_{TCF} = temperature corrected flux
 TMP = transmembrane pressure

To calculate the temperature corrected flux, use the following equation:

$$q_{\text{TCF}} = \frac{Q_p}{A \times \text{TCF}}$$

where

Q_p = permeate flow rate
 A = membrane area
 TCF = temperature correction factor

The temperature correction factor (TCF) can be calculated with the following equation:

$$\text{TCF} = e^{1100 \left(\frac{1}{298} - \frac{1}{T} \right)}$$

where

T = °C + 273.15

6.7 SHIPPING AND STORAGE

When not in operation the membrane must be kept saturated with good quality feedwater (meeting Guidelines) and having a low TDS (< 2000 mg/L) at all times. The as-shipped elements must be kept sealed in its original double plastic bag, in a cool, dry place, out of direct sunlight, until required for installation.

TABLE 10. MEMBRANE SPECIFICATIONS FOR MICRODYN *iSep* UF MODULES.

Minimum Storage Temperature *	Maximum Storage Temperature
-15°C (5°F)	30°C (86°F)

* If membrane modules freeze, please thaw completely before use.

Only glycerin may be used as a freeze protection agent, but is not necessary (if modules freeze, thaw before use). 1 wt% sodium metabisulfite or MICRODYN-NADIR approved biocide may be used for storage, shipping or continuous module shutdowns in excess of 5 days to prevent biological growth. It is imperative to properly follow element storage instructions as membrane transport properties can be permanently compromised if not properly followed.

At all times during storage, MICRODYN *iSep*™ 500 UF modules must be fully saturated with water of UF permeate quality or better so as to prevent pore drying.

For systems that will be temporarily shut down for short periods of time (less than 2-3 weeks), the *iSep* modules should be stored in a solution of water and sodium hypochlorite at neutral pH. Water quality shall be UF permeate or better. A free chlorine residual of 2.0 - 5.0 mg/L should be maintained within the membrane tank at all times throughout this period. This will minimize microbiological activity and reduce the chance of scaling. A new solution should be prepared weekly. *iSep* modules stored in the factory shipping solution will retain the flow/particulate retention characteristics for a period of at least twelve (12) months from date of shipment ex-works, or twelve (12) months following the addition of the sanitizing/storage solution if the elements remain sealed, away from direct sunlight, and at storage temperatures between 0 - 25°C (32 - 77°F). The optimal storage temperature for periods exceeding three (3) months is 15°C (60 °F). If elements are to be stored for periods greater than twelve (12) months, consult MICRODYN-NADIR for procedures to minimize long-term effects.

For systems that will be out of service for more than 2 - 3 weeks, it is recommended that all elements be removed from the system and vacuum sealed (if possible) in individual bags with a storage solution of 1 wt% sodium metabisulfite and 18% glycerin (if needed) in RO permeate water at a pH of 3 - 4, and replaced monthly.